



www.zoom-room.com

'THE STANDARD' SIDE CABINET ASSEMBLY DRAWINGS

THANKS FOR PURCHAING ZOOM-ROOM™, AND CONGRATULATIONS ON OWNING THE MOST SOPHISTICATED REMOTE CONTROLLED RETRACTABLE BED SYSTEM.

TO ENSURE PROPER CONSTRUCTION OF YOUR STANDARD LINE OF CABINETRY, FOLLOW ALL DIRECTIONS IN ORDER, AND DO NOT HESITATE TO CONTACT OUR TOLL-FREE NUMBER (888) 211-1120 IF YOU NEED FURTHER ASSISTANCE. PLEASE CALL BETWEEN 10AM - 5PM EASTERN STANDARD TIME.

FOR SAFETY, THE ASSEMBLY OF THE CABINETS REQUIRES AT LEAST TWO PEOPLE, AS MANY OF THE PANELS AND COMPONENTS ARE HEAVY AND LARGE. ALL INSTALLERS MUST BE ABLE TO CARRY THE COMPONENTS WITHOUT STRAINING, REMEMBER TO USE PROPER LIFTING TECHNIQUE WHEN WORKING WITH HEAVY ITEMS.



SIDE CABINET

FOR FURTHER INFORMATION, PLEASE CONTACT:

ZOOM-ROOM
2121 N. BAYSHORE DR. #709
MIAMI, FL - 33137
T. (888) 211-1120
T. (305) 677-9148
F. (305) 677-9278
INQUIRIES@ZOOM-ROOM.COM
WWW.ZOOM-ROOM.COM

THE STANDARD SIDE CABINET PANELS

BEFORE YOU START, MAKE SURE YOU HAVE RECEIVED ALL PANELS NEEDED TO CONSTRUCT THE SIDE CABINET

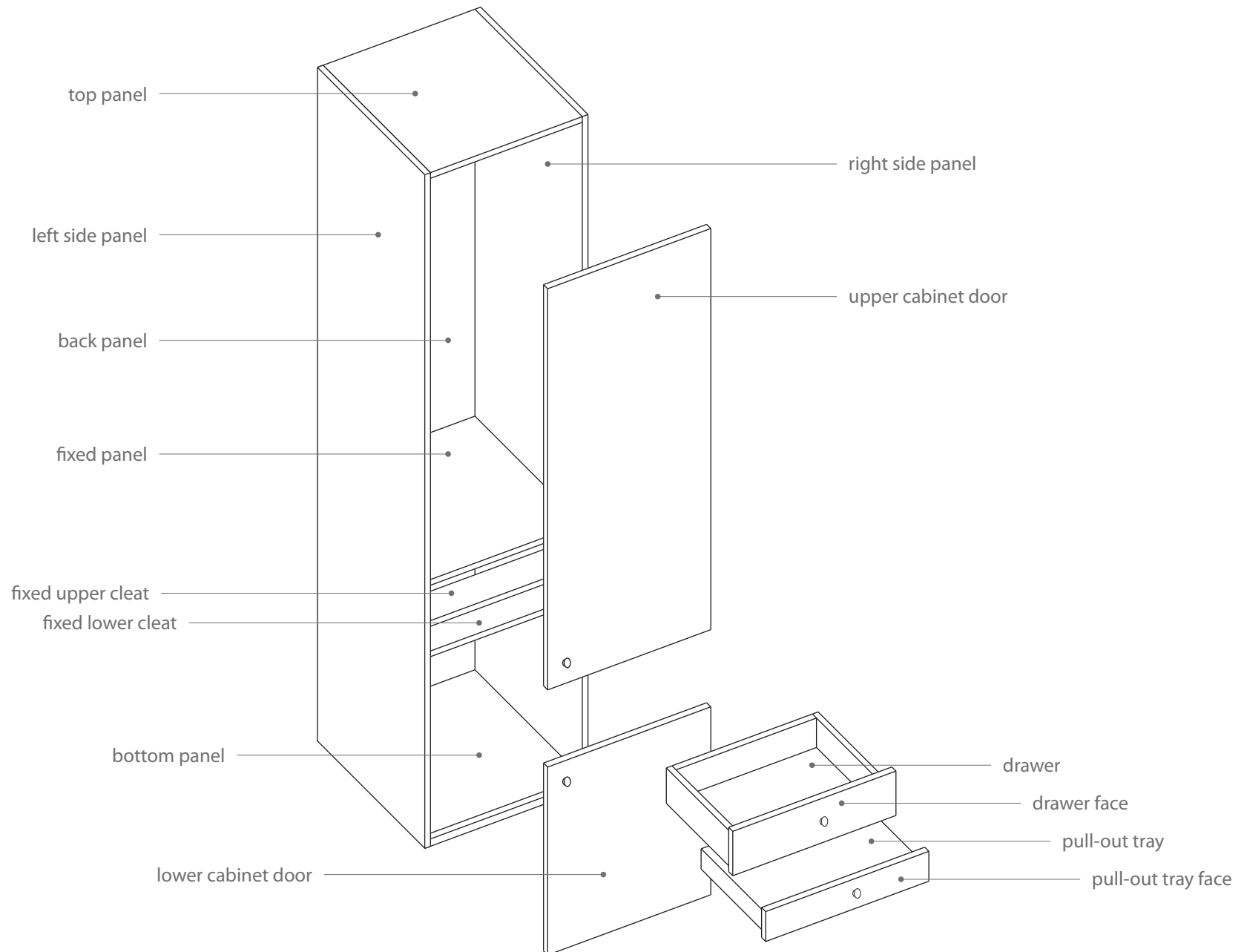

TOOLS NEEDED:

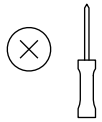

YOU WILL NEED A PHILLIPS SCREWDRIVER TO TIGHTEN THE FASTENERS

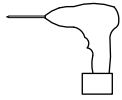

YOU WILL NEED A POWER DRILL

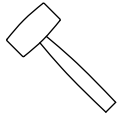

YOU WILL NEED A MALLET TO TAP CERTAIN PANELS SECURELY INTO PLACE.

THE STANDARD SIDE CABINET ASSEMBLY HARDWARE

BEFORE YOU BEGIN ASSEMBLING THE PANELS, MAKE SURE ALL REQUIRED HARDWARE IS INCLUDED

PLEASE SEE THE LEGENDS ON EACH PAGE FOR GUIDANCE ABOUT ATTACHING THE CORRECT HARDWARE TO ITS PROPER PANELS AND LOCATION. NOTE THAT SOME HARDWARE HAS BEEN PRE-INSTALLED

NOTE: SOME STEPS MAY REQUIRE THE ASSISTANCE OF ANOTHER PERSON

ATTACHMENT HARDWARE

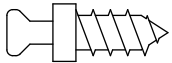

QUARTER-TURN PEG QUANTITY x 24
(used with quarter-turn fasteners to connect panels together)



EURO SCREWS QUANTITY x 24

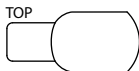

ADJUSTABLE CLIPS QUANTITY x 12
(used to support shelves)

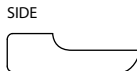

ROUND STICKERS QUANTITY x 4
(used to cover screw heads)

DRAWER AND PULL-TRAY SLIDES



LEFT DRAWER SLIDE



LEFT PULL-TRAY SLIDE



RIGHT DRAWER SLIDE



RIGHT PULL-TRAY SLIDE

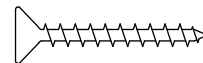

1" SCREW QUANTITY x 2



1 1/4" SCREW QUANTITY x 6

NOTE: 1" SCREWS ARE USED TO ATTACH THE DRAWER FACE TO THE DRAWER

1 1/4" SCREWS ARE USED TO ATTACH THE PULL-OUT TRAY FACE TO THE PULL-OUT TRAY, AND TO SECURE THE SIDE CABINET TO THE CENTER CABINET

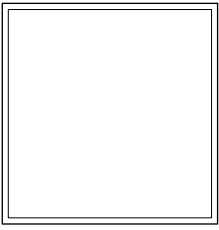

drawer box



pull-out table

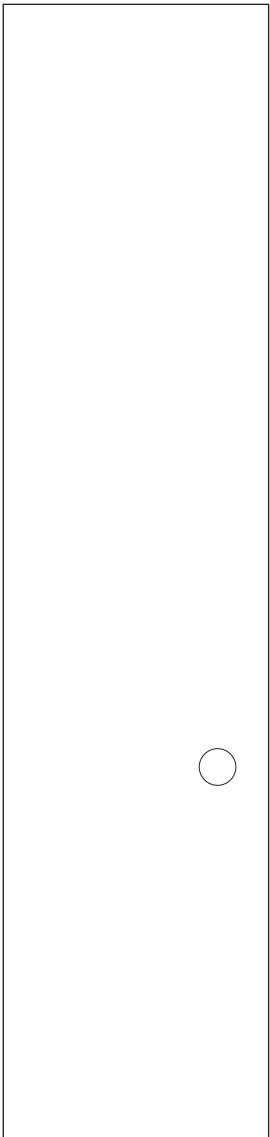

back panel

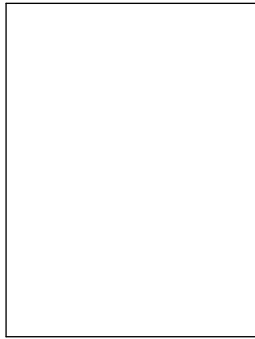

top panel



adjustable shelf

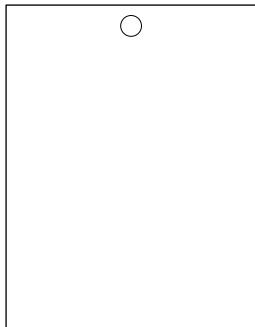

fixed panel



adjustable shelf

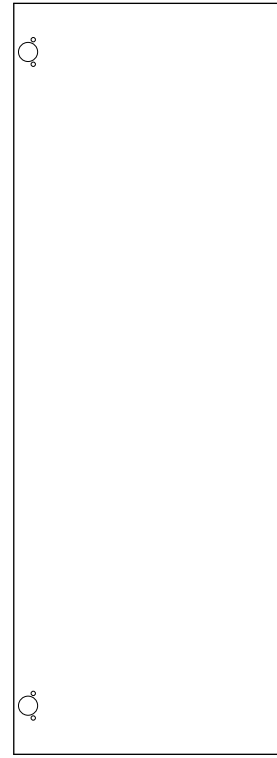

upper door panel



fixed upper cleat



adjustable shelf



drawer face



fixed lower cleat

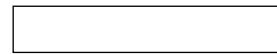

pull-out tray face

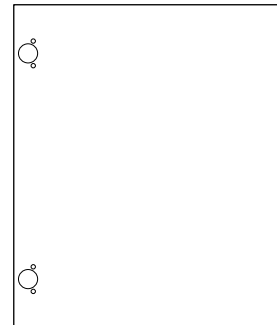

lower door panel

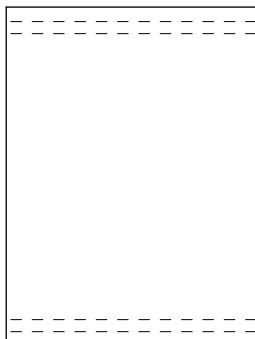

bottom panel -
(toe-kicks pre-installed)

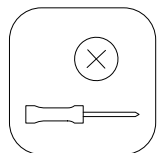
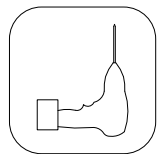
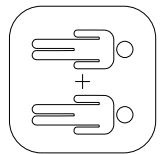
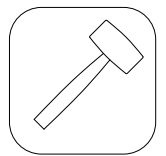

THE STANDARD SIDE CABINET PANELS

STEP 1: ATTACH HARDWARE TO SIDE PANELS AND DOORS

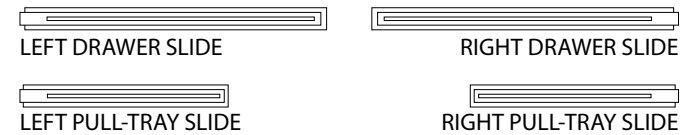
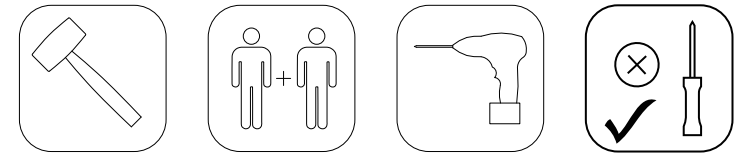
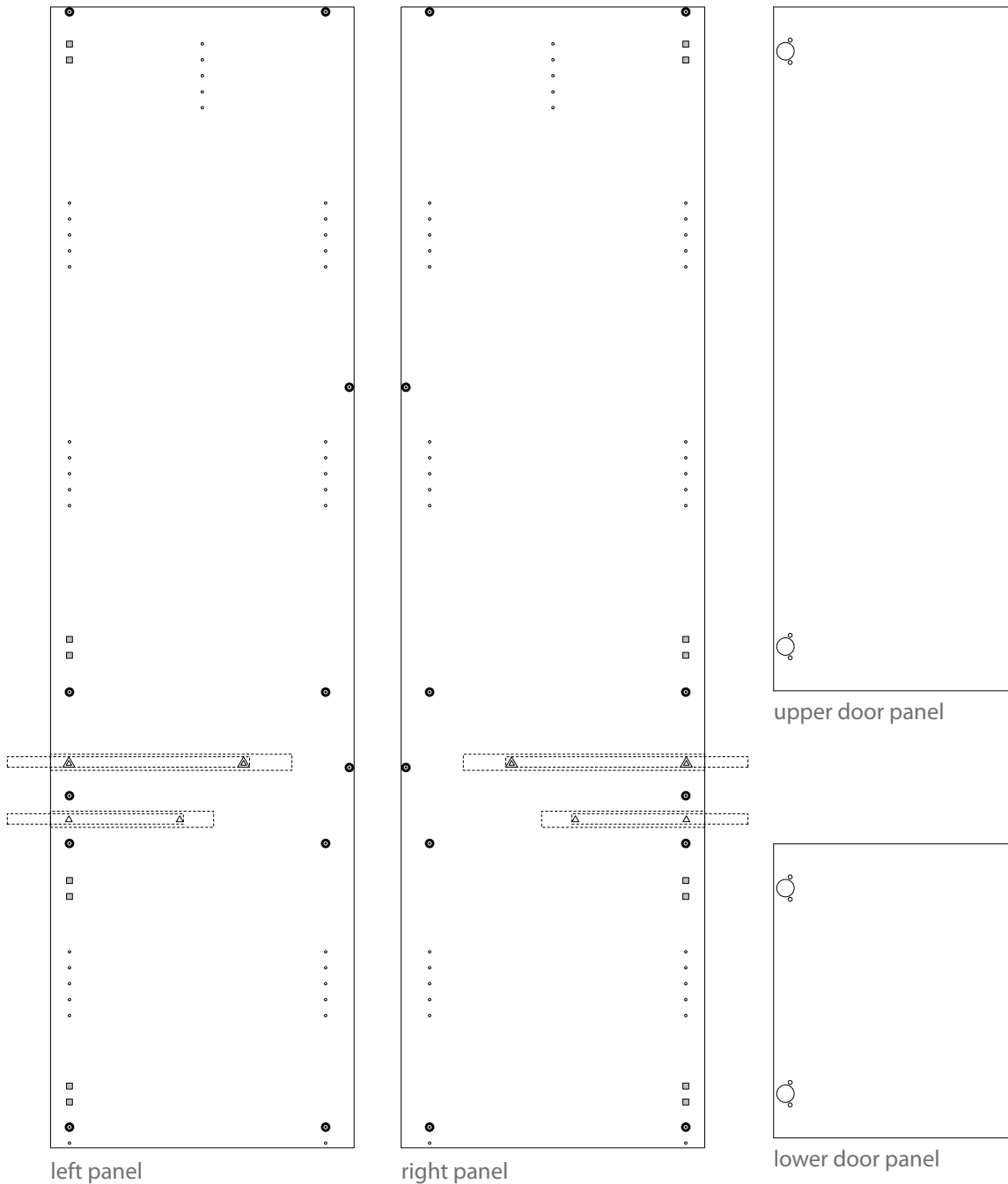



INSTRUCTIONS:

 x 22 **QUARTER-TURN PEGS** - ATTACH THE QUARTER-TURN PEGS IN THE LOCATIONS SPECIFIED BY A BLACK DOT (11 PER SIDE PANEL)

 **DOOR HINGE** - ATTACH THE METAL DOOR HINGES TO THE DOOR PANELS (THE HINGES SIMPLY SNAP IN PLACE). REMEMBER THE DOORS ARE REVERSIBLE; KEEP IN MIND WHICH WAY YOU WANT THEM TO SWING OPEN

 **DOOR ATTACHMENT LOCATION** - THE GRAY SQUARES DESIGNATE THE POSSIBLE LOCATIONS FOR MOUNTING THE DOORS TO THE PANELS. REMEMBER THE DOORS ARE REVERSIBLE; KEEP IN MIND WHICH WAY YOU WANT THEM TO SWING OPEN

 x 4 **DRAWER SLIDE ATTACHMENT LOCATION** - MOUNT THE DRAWER SLIDES (LONGER SLIDES) IN THE LOCATIONS DESIGNATED BY THE DOUBLE-TRIANGLES. MAKE SURE THAT THE SLIDES MOVE OUTWARDS TOWARDS THE FRONT OF THE CABINET

 x 4 **TRAY SLIDE ATTACHMENT LOCATION** - MOUNT THE PULL-OUT TRAY SLIDES (SMALLER SLIDES) IN THE LOCATIONS DESIGNATED BY THE SINGLE-TRIANGLES. MAKE SURE THAT THE SLIDES MOVE OUTWARDS TOWARDS THE FRONT OF THE CABINET

STEP 2: ATTACH SIDE PANELS TO BOTTOM PANEL

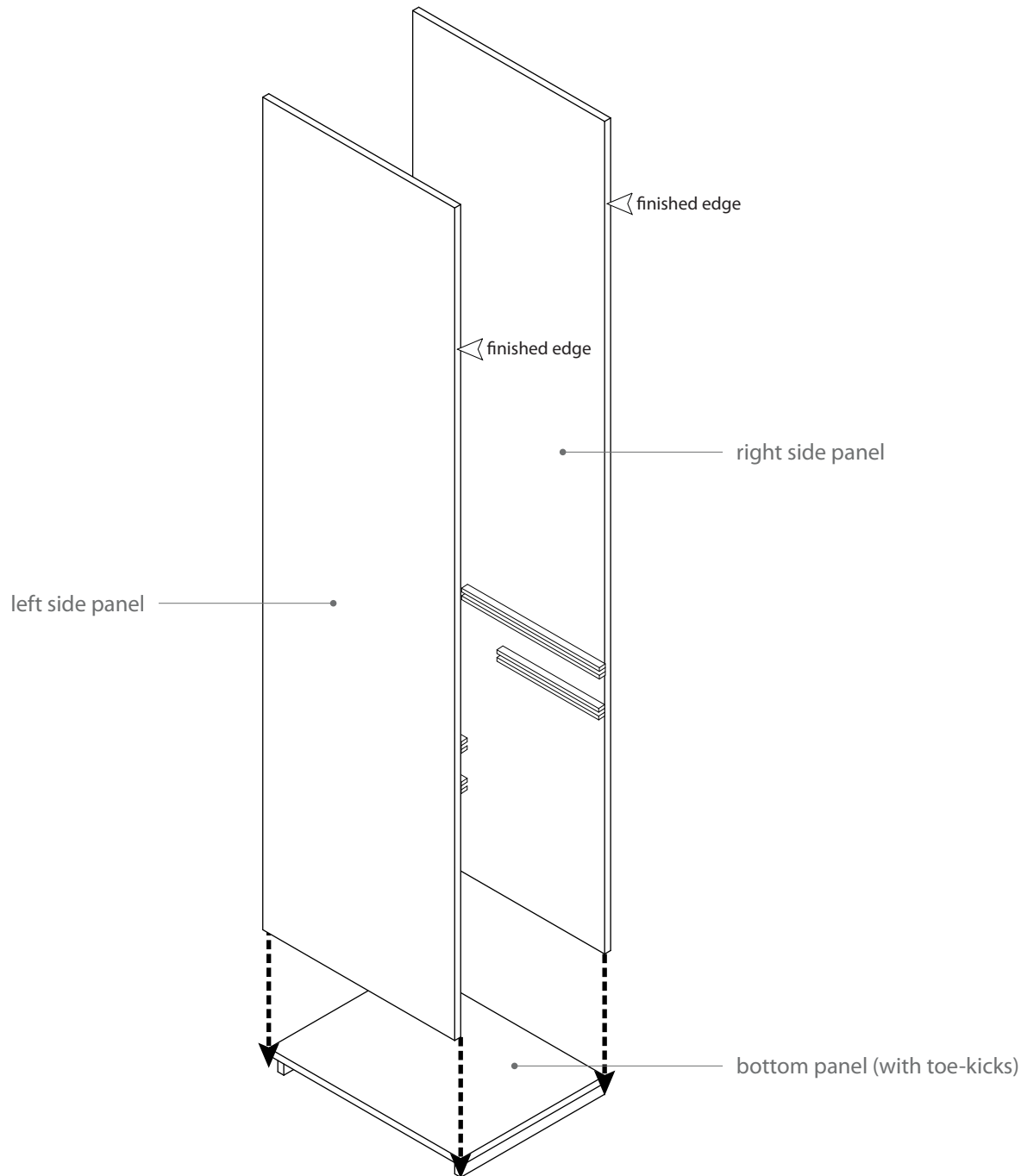
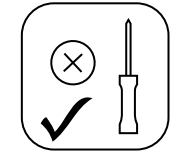
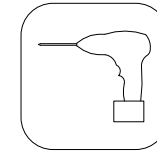
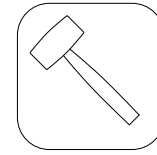

INSTRUCTIONS:

CAREFULLY SLIDE THE SIDE PANELS INTO THE BOTTOM PANEL, MAKING SURE THE QUARTER-TURN PEGS CONNECT PROPERLY TO THE BOTTOM PANEL TIGHTEN THE FASTENERS WITH YOUR SCREWDRIVER

NOTE: A SECOND PERSON IS REQUIRED FOR THIS STEP

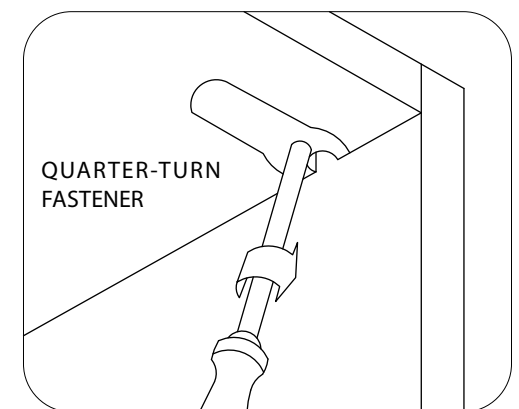

STEP 3: ATTACH BACK PANEL TO BOTTOM & SIDE PANELS

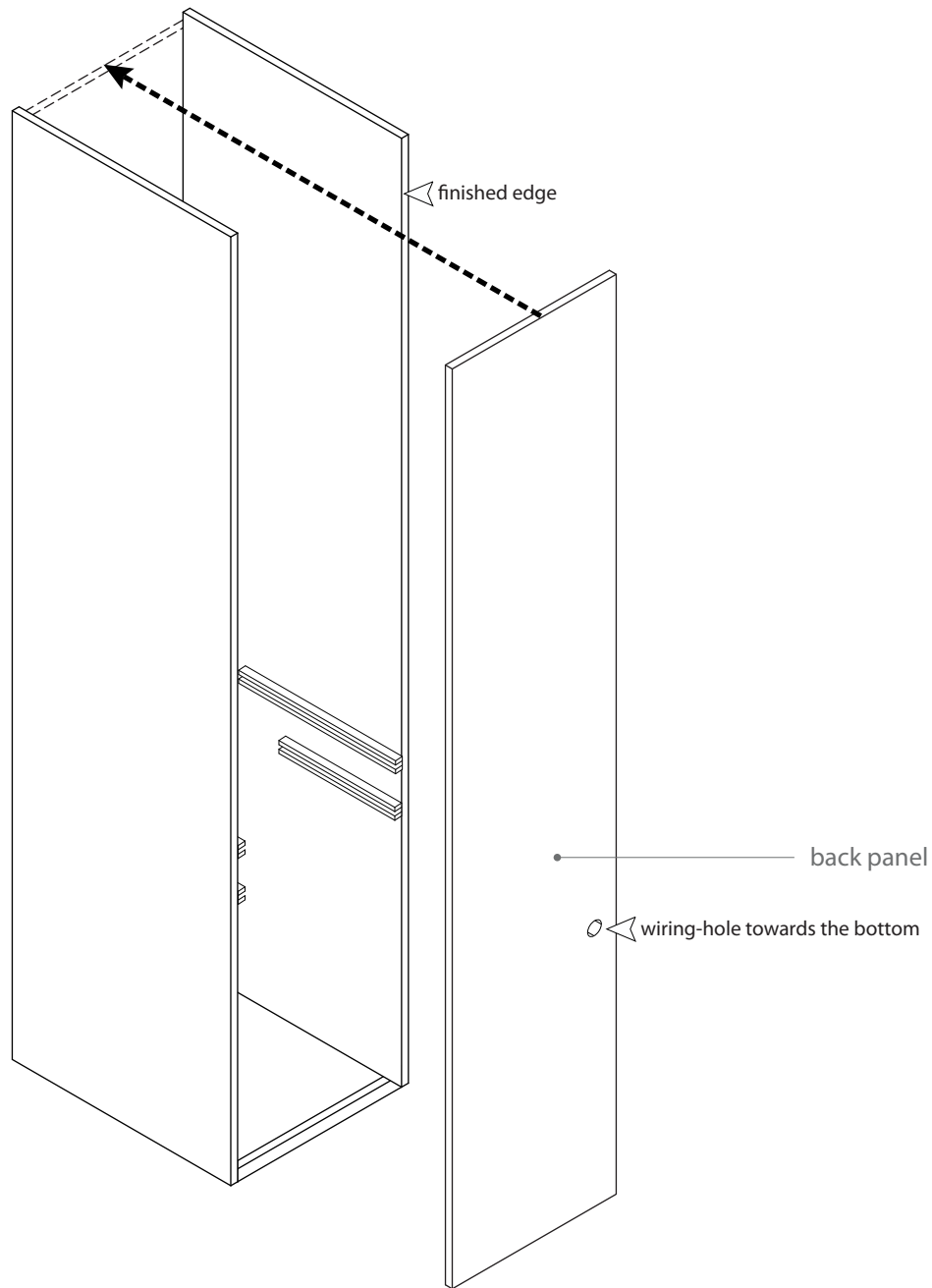
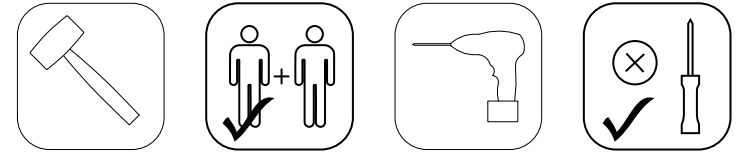

INSTRUCTIONS:

CAREFULLY SLIDE THE BACK PANEL IN BETWEEN THE TWO SIDE PANELS, MAKING SURE THE QUARTER-TURN PEGS CONNECT TO THE BOTTOM AND SIDE PANELS CORRECTLY. TIGHTEN THE FASTENERS WITH YOUR SCREWDRIVER

NOTE: A SECOND PERSON IS REQUIRED FOR THIS STEP. THE WIRING-HOLE IN THE BACK PANEL SHOULD BE TOWARDS THE BOTTOM OF THE CABINET

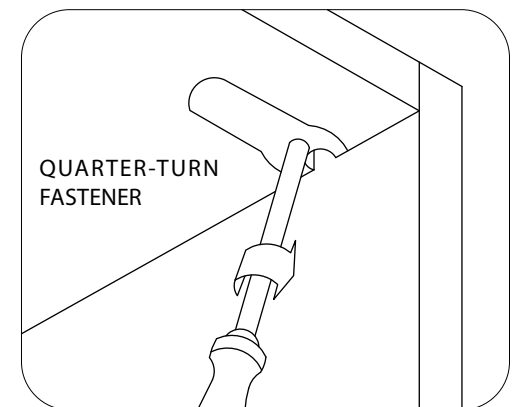

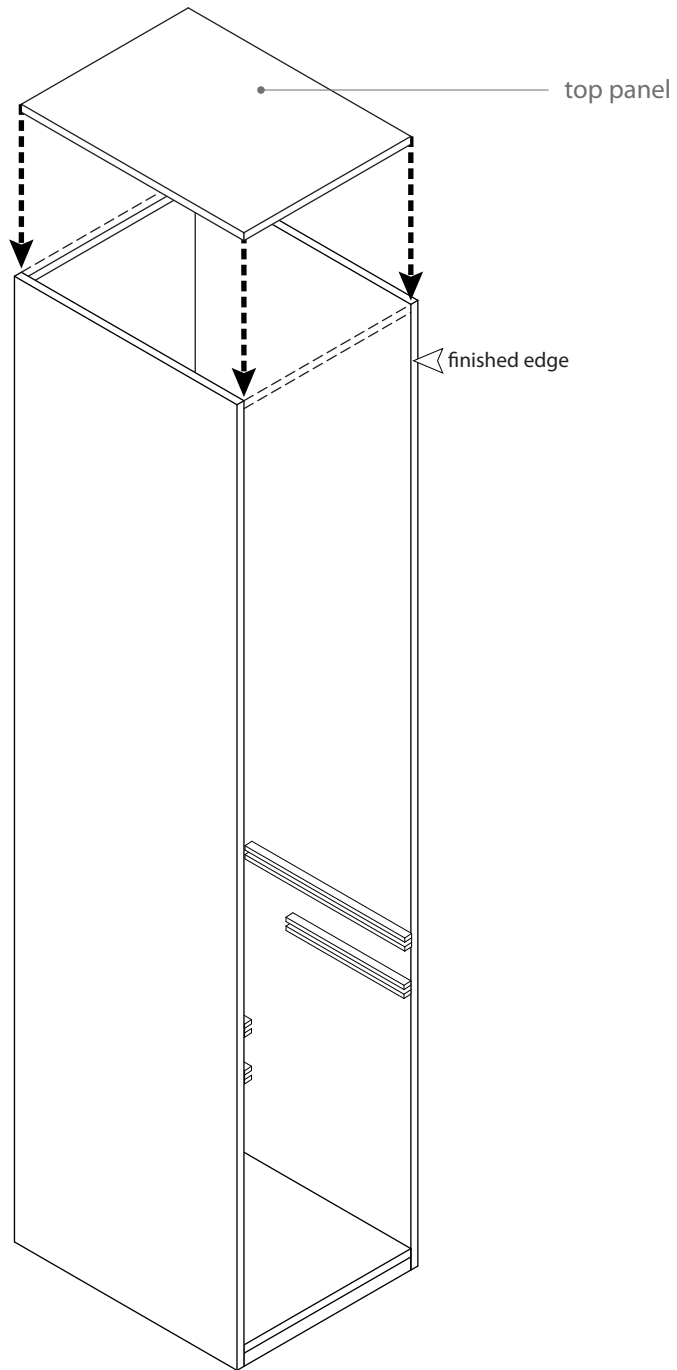

STEP 4: ATTACH TOP PANEL TO SIDE PANELS

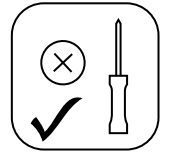
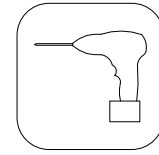
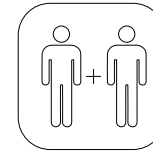
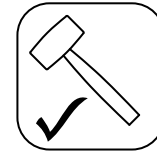

INSTRUCTIONS:

PUSH THE TOP PANEL DOWN INTO PLACE (YOU MAY NEED TO TAP THE PANEL WITH A Mallet TO SECURE IT). TIGHTEN THE FASTENERS WITH YOUR SCREWDRIVER

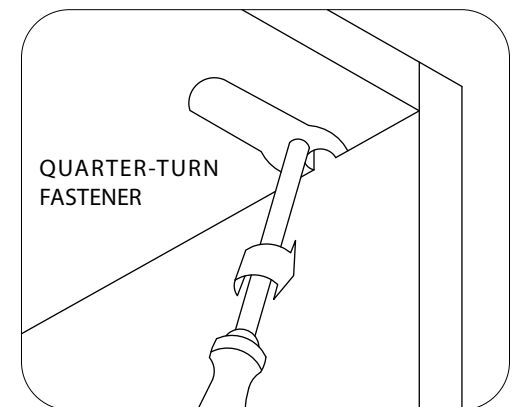

STEP 5: ATTACH FIXED PANEL TO SIDE PANELS

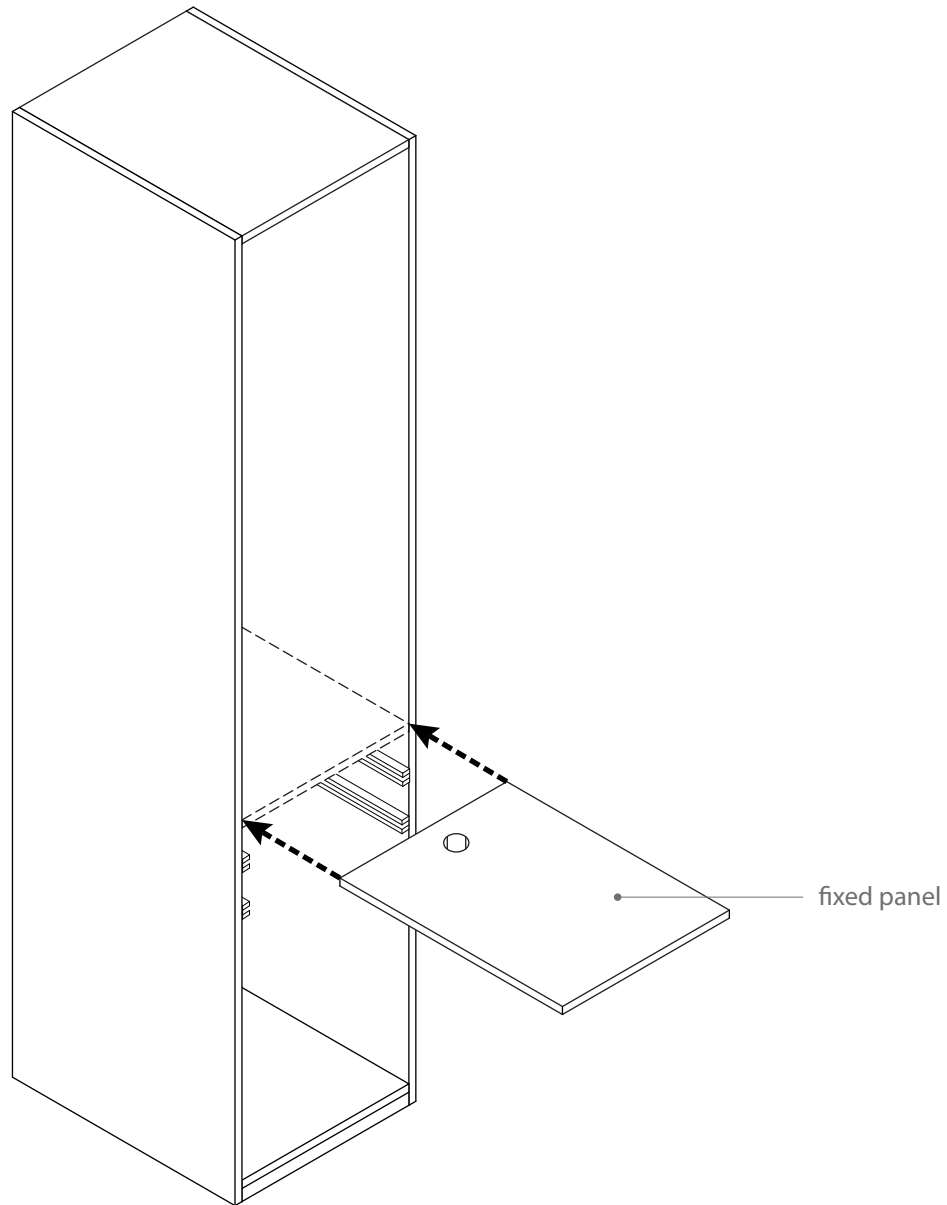
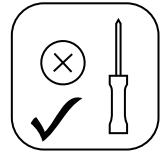
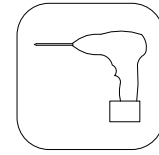
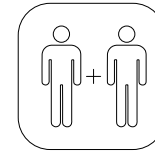
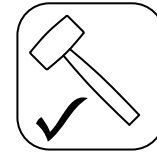

INSTRUCTIONS:

SLIDE THE FIXED PANEL INTO PLACE (YOU MAY NEED TO TAP THE PANEL WITH A Mallet TO SECURE IT). TIGHTEN THE FASTENERS WITH YOUR SCREWDRIVER

NOTE: THE FIXED PANEL HAS WIRING-HOLE

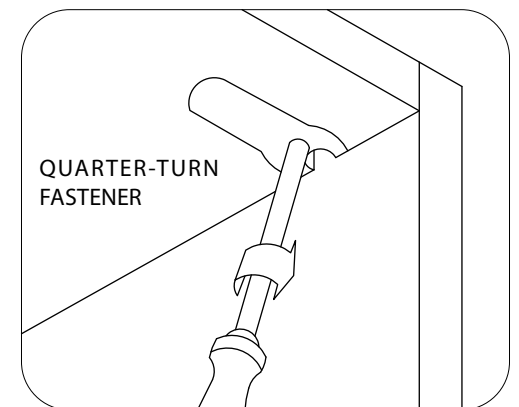

STEP 6: ATTACH FIXED CLEATS TO SIDE PANELS

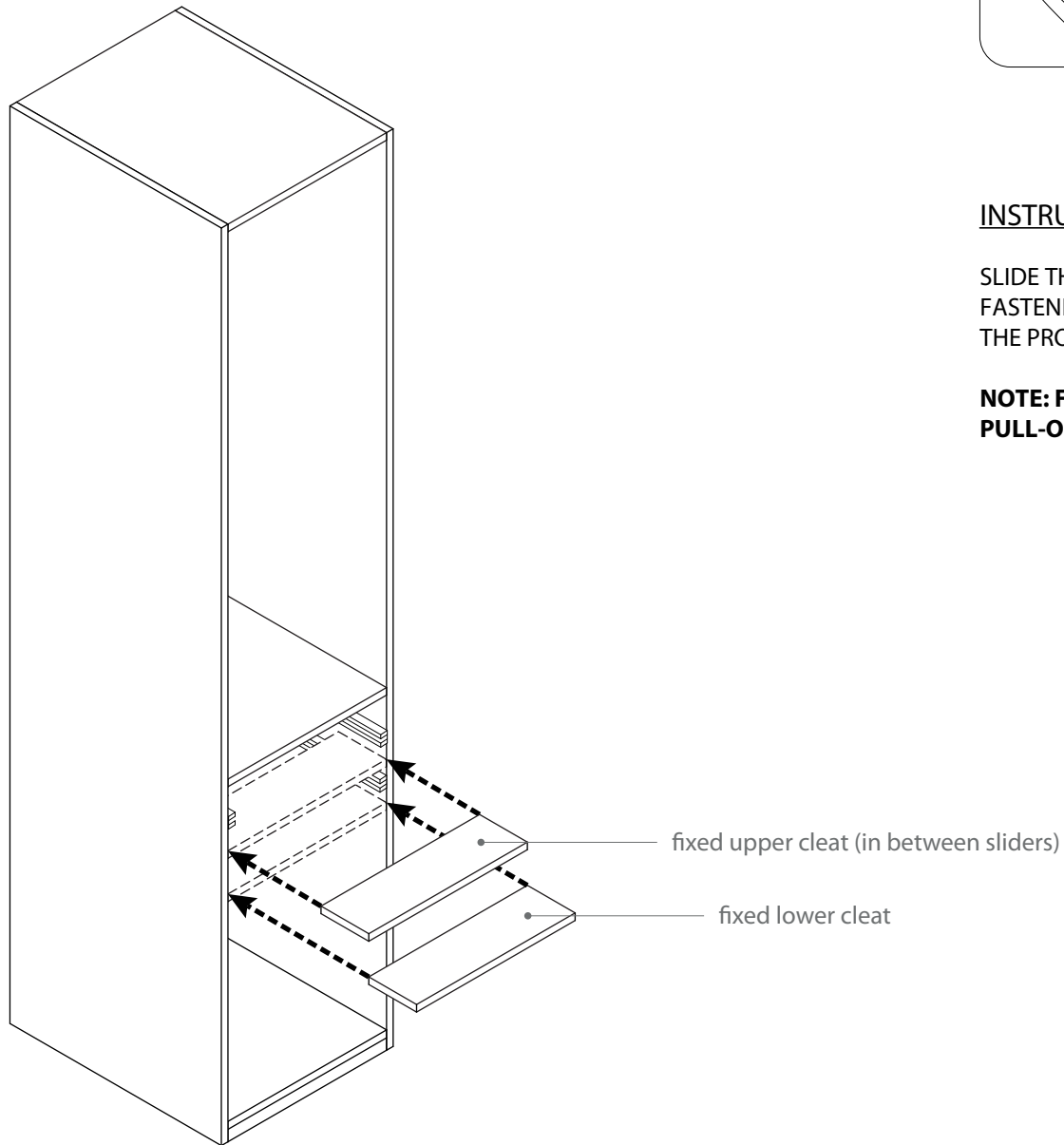
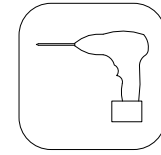
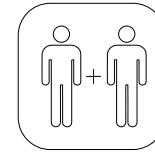
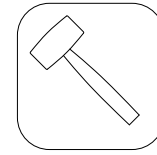

INSTRUCTIONS:

SLIDE THE FIXED UPPER CLEAT INTO PLACE AND TIGHTEN THE FASTENERS WITH YOUR SCREWDRIVER FIRST, THEN REPEAT THE PROCESS FOR THE LOWER FIXED CLEAT.

NOTE: FIXED UPPER CLEAT GOES BETWEEN THE DRAWER AND PULL-OUT TRAY SLIDES

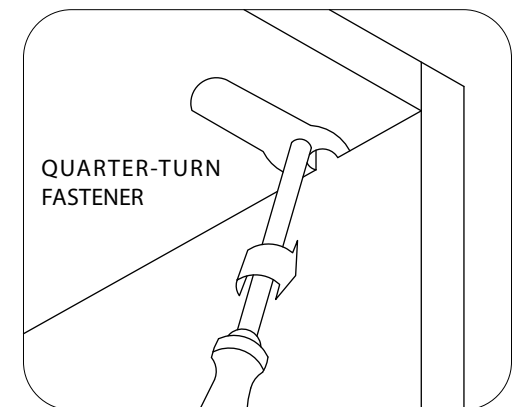

STEP 7: ATTACH DRAWER AND PULL-OUT TRAY FACES

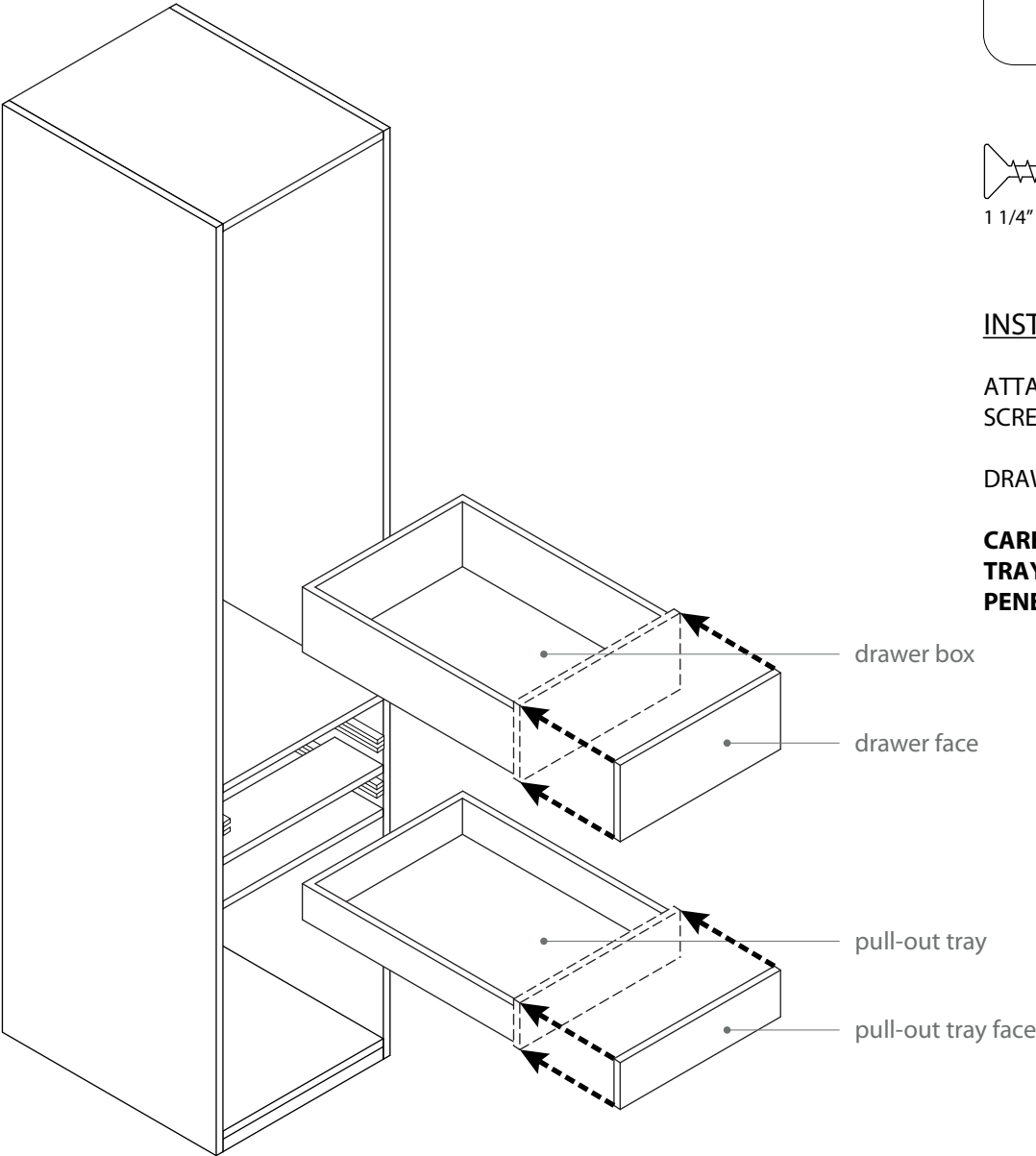
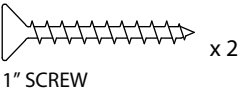
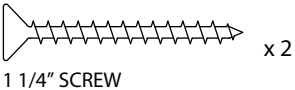
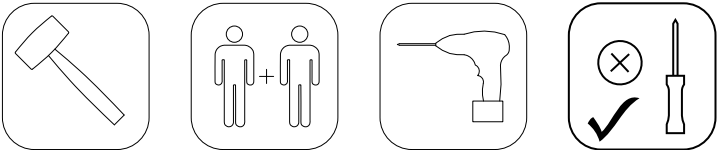

INSTRUCTIONS:

ATTACH THE DRAWER AND PULL-OUT TRAY FACES USING 1" SCREWS (DRAWER FACE) AND 1 1/4" SCREWS (PULL-OUT TRAY)

DRAWER BOX AND PULL-OUT TRAY COME PRE-ASSEMBLED

CAREFUL!! DRAWER FACE USES 1" SCREWS. PULL-OUT TRAY FACE USES 1 1/4" SCREWS. LONGER SCREWS MAY PENETRATE THROUGH THE FINISH SIDE OF THE PANELS

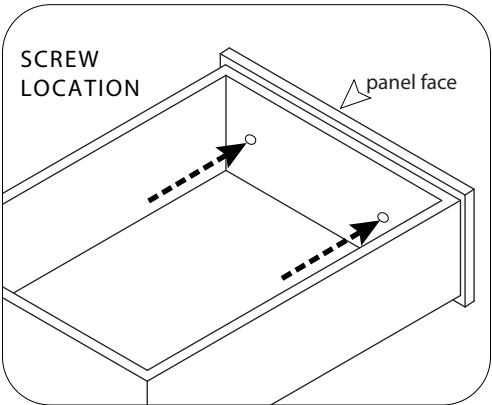

STEP 8: SECURE SIDE CABINET TO CENTER CABINET

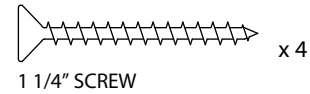
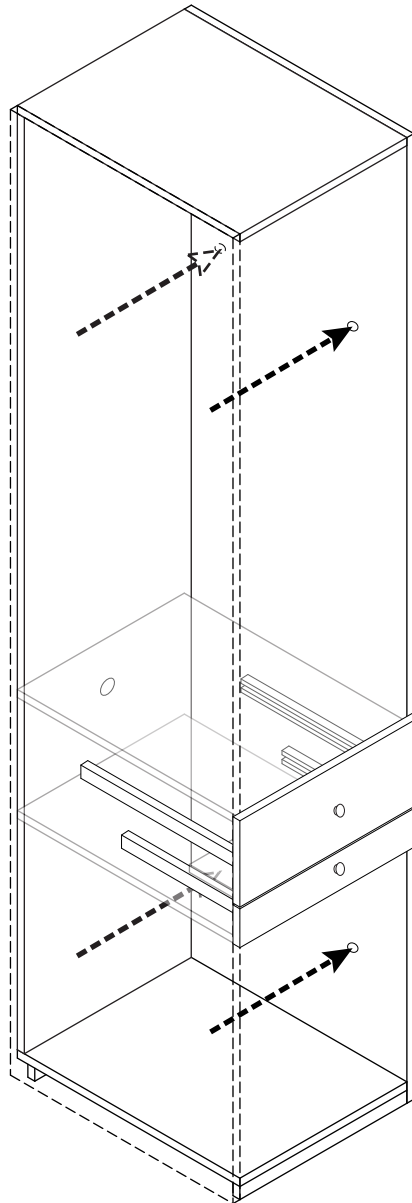
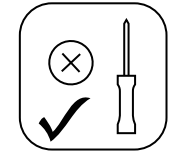
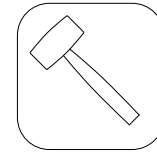

INSTRUCTIONS:

SECURE THE SIDE CABINET TO CENTER CABINET (NOT SHOWN) USING 1 1/4" SCREWS. COVER SCREWHEADS USING THE DECORATIVE STICKERS

A SECOND PERSON MAY BE REQUIRED FOR THIS STEP

CAREFUL!! USING LONGER SCREWS MAY PENETRATE THROUGH THE INSIDE OF THE CENTER CABINET, AND POSSIBLY DAMAGE THE BED MECHANISM AND/OR MATTRESS DURING OPERATION

STEP 9 (OPTIONAL): INSTALL ADJUSTABLE SHELVES OR HANGING ROD

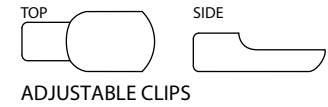
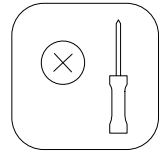
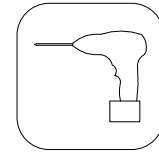
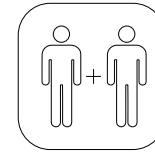
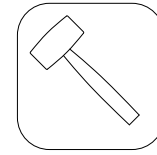

x 12

INSTRUCTIONS:

INSTALL THE OPTIONAL ADJUSTABLE SHELVES OR HANGING ROD ACCORDING TO YOUR PREFERENCE

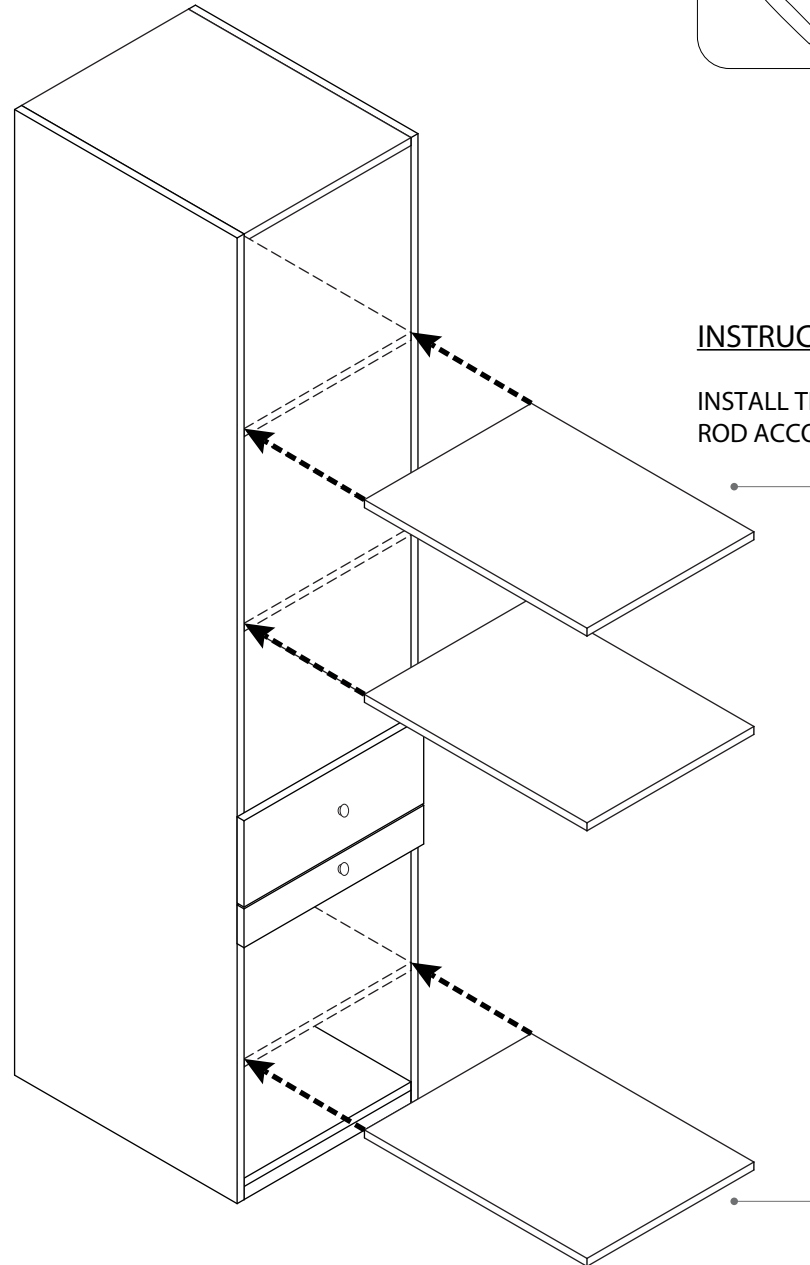
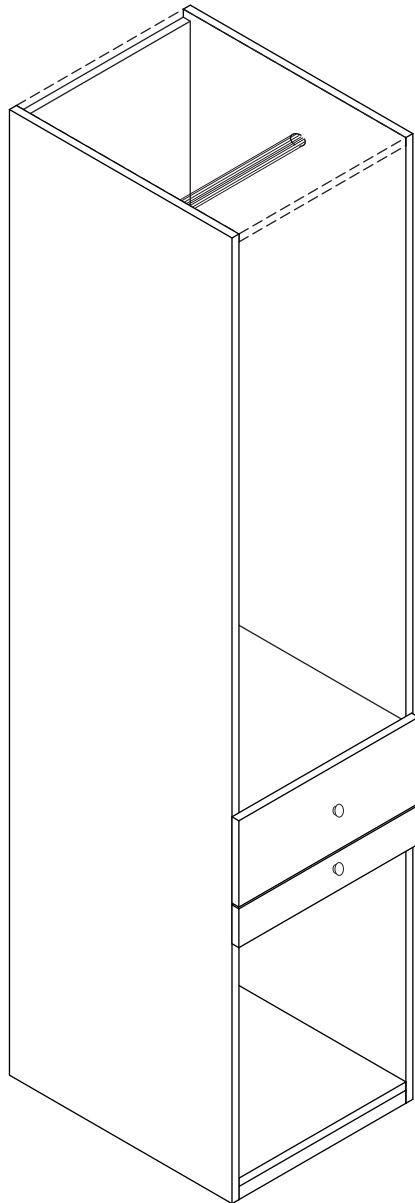

adjustable shelves

STEP 10: ATTACH CABINET DOORS

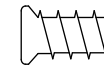
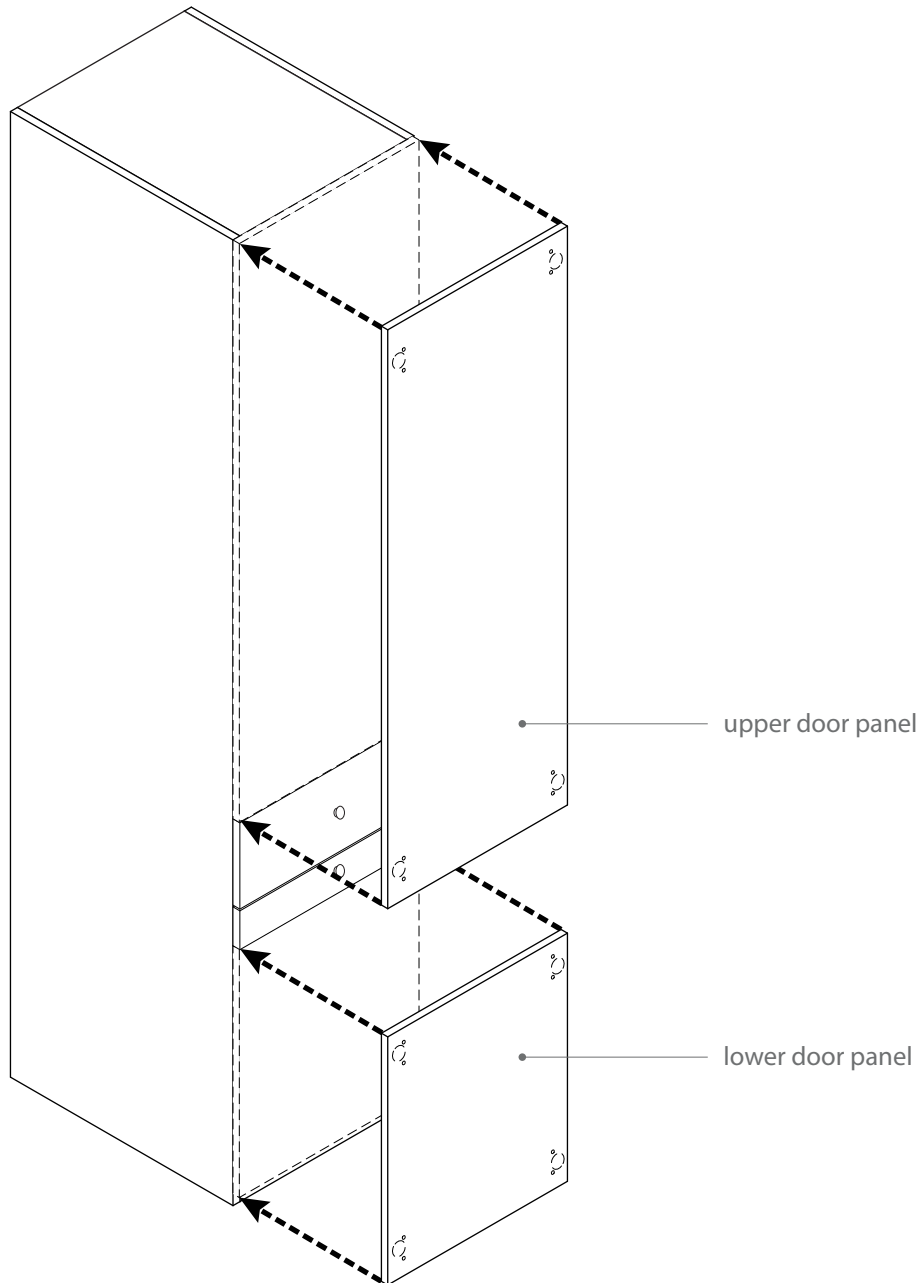
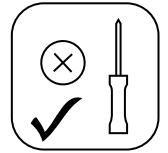
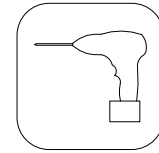
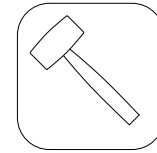

x 8

INSTRUCTIONS:

ATTACH THE DOORS TO THE CABINET USING EURO SCREWS (2 PER HINGE)

NOTE: A SECOND PERSON IS REQUIRED FOR THIS STEP. THE CABINET DOORS ARE REVERSIBLE; MOUNT HINGES ACCORDING TO YOUR PREFERENCE